



# Council of Southern Caving Clubs

A constituent member of the British Caving Association

## Anchor Placement & Installation

Document Type: **Guidance Note**

Document Number: **CSCC-EQ-GN-1001**

Document Author: **Faye Litherland**

This document contains proprietary information belonging to the Council of Southern Caving Clubs and shall be used only for the purpose for which it was supplied. It shall not be copied, reproduced or otherwise used, nor shall such information be furnished in whole or in part to others, except in accordance with the terms of any agreement under which it was supplied or with the prior written consent of the Council of Southern Caving Clubs and shall be returned upon request.

2	15 June 2010	Updated following officers comments	FDAL		
1	21 April 2010	First Issue	FDAL		
<b>ISSUE</b>	<b>DATE</b>	<b>DESCRIPTION</b>	<b>BY</b>	<b>CHECKED</b>	<b>APPROVED</b>

FILE NAME CSCC-EQ-GN-1001 Rev 2 Anchor Placement & Installation Guidance	 <b>Council of Southern Caving Clubs</b> <small>A constituent member of the British Caving Association</small>	PAGE <b>1 of 11</b>	ISSUE <b>2</b>	DOCUMENT No. <b>CSCC-EQ-GN-1001</b>
---	--	------------------------	-------------------	--

**CONTENTS**

	<b>Page</b>
<b>1 PURPOSE</b>	<b>3</b>
<b>2 INTRODUCTION</b>	<b>3</b>
<b>3 MATERIALS</b>	<b>3</b>
<b>3.1 The Anchors</b>	<b>3</b>
<b>3.1.1 Resin Anchors</b>	<b>3</b>
<b>3.1.2 Mechanical Anchors</b>	<b>3</b>
<b>3.2 Wear &amp; Tear on Anchors</b>	<b>4</b>
<b>3.3 Corrosion</b>	<b>4</b>
<b>3.4 Anchor Resin</b>	<b>5</b>
<b>3.5 Anchor Placement</b>	<b>6</b>
<b>3.6 Choice of Anchor Type</b>	<b>6</b>
<b>3.7 Method of Installation for Resin Anchors</b>	<b>7</b>
<b>3.8 Method of Installation for Mechanical Anchors</b>	<b>8</b>
<b>3.9 Method of Anchor Removal</b>	<b>8</b>
<b>APPENDIX A</b>	<b>9</b>

# 1 Purpose

This document forms part of a suite of documents to manage the CSCC Anchor Placement Scheme. There are three documents in the pack.

CSCC-EQ-GN-1001 Anchor Placement & Installation Guidance

CSCC-EQ-GN-1002 Anchor Inspection & Usage

CSCC-EQ-PR-1001 Anchor Management (Installation, Testing, Defect Reporting) Procedure

These documents are designed to work together. It is important that anyone using or installing anchors familiarises themselves with the contents of these documents.

All of the above documents shall be available on the CSCC Website.

## 2 Introduction

- 1.1.1 This document shall not be assumed to be a definitive guide to anchor placement and installation. The information contained is for guidance only. This guidance is of a general nature and is based on sources of information currently available. Whilst CSCC has used its best endeavours to ensure the accuracy of the guidance we cannot accept responsibility for any liability resulting from its use.
- 1.1.2 It is expected and assumed that those individuals planning on placing anchors have sufficient experience to enable them to evaluate the rock conditions and make appropriate judgements on the appropriate anchor type and number of anchors required to provide a working solution.
- 1.1.3 This information is designed to supplement a practical demonstration session which will be organised by the CSCC Equipment Officer on request.

## 3 Materials

### 3.1 The Anchors

#### 3.1.1 Resin Anchors

The original Eco anchor was produced by DMM in 8mm diameter 316 grade stainless steel. Subsequently DMM ceased production of the Eco anchor and a new replacement (the Peco anchor) which conforms to the original specification has been sourced from China. From tests carried out it has been determined that, under test conditions, this anchor performs the same as the original DMM anchor. When installed there is visually no difference between the two. The 8mm bar common to both anchors is formed into a 'P' shape which requires a drilled hole of 18mm diameter x 100mm deep.

Petzl manufacture a 10mm (BAT'INOX) and 14mm (COLLINOX) multidirectional resin anchor which can be installed in the same manner as the Peco anchor above. The resin to be used in this case would be the Petzl resin ampoules provided by Petzl for each anchor type.

#### 3.1.2 Mechanical Anchors

Petzl 8mm self-drilling anchor.

FILE NAME CSCC-EQ-GN-1001 Rev 2 Anchor Placement & Installation Guidance	 <b>Council of Southern Caving Clubs</b> <small>A constituent member of the British Caving Association</small>	PAGE <b>3 of 11</b>	ISSUE <b>2</b>	DOCUMENT No. <b>CSCC-EQ-GN-1001</b>
---	--	------------------------	-------------------	--

The anchor is placed onto a device called the driver, which enables it to be hammered into the rock. By modern standards these anchors are weak, even when placed in hard rock such as granite.

Petzl 10mm through bolt.

A hole is drilled to the required depth and the anchor hammered, complete with attached hanger, washer and nut, into the hole. Tightening the nut draws the tapered end of the bolt into the metal collar causing it to expand. Once the nut has been tightened (never over-tighten it) the unit is ready for use. From a conservation point of view it is good practice to drill the hole deep enough so the bolt can be hammered into the rock when, in future years, it corrodes, as once expanded they cannot be easily extracted. However, never knock the bolt back into the rock and retighten it, as the unit is then likely to be unsafe.

### 3.2 Wear & Tear on Anchors

Due to the mechanical properties of 316 grade stainless steel, the eco anchors and other 316 stainless steel bolts should display very little wear over time, even when placed on popular routes. Eco anchors placed in Swinsto Hole, Yorkshire (1991) show very little sign of wear on their inner curvatures. However, wear has been observed on anchors used by caving instructors lowering off novices from the Upper Series back down into the Crabwalk in Giants Hole, Derbyshire. Should an anchor be suspected of failing the standard inspection (See document CSCC-EQ-GN-1002) it should be deemed unsafe and reported to the CSCC Equipment Officer.

The CSCC Equipment Officer is responsible for ensuring that any suspect anchor is checked and if necessary replaced. Although the Eco anchor has considerable strength, safe rigging practices should still be observed i.e. back ups & 'Y' hangs etc.

### 3.3 Corrosion

Although stainless steel is much more resistant to corrosion than ordinary carbon or alloy steels, in some circumstances it can corrode. Normally, stainless steel does not corrode uniformly as do ordinary carbon and alloy steels and corrosion is often not visible until significant mechanical weakening has taken place. Therefore, it is vital to ensure that anchors are correctly placed so that equipment can be backed up in case of unexpected failure.

The types of corrosion which could affect a stainless steel anchor are:

**Pitting corrosion** - The passive layer on stainless steel can be attacked by certain chemical species. The chloride ion Cl<sup>-</sup> is the most common of these and is found in everyday materials such as salt and bleach. Pitting corrosion is avoided by making sure that stainless steel does not come into prolonged contact with harmful chemicals.

**Crevice corrosion** - Stainless steel requires a supply of oxygen to make sure that the passive layer can form on the surface. In very tight crevices, it is not always possible for the oxygen to gain access to the stainless steel surface thereby causing it to be vulnerable to attack.

**Galvanic (contact) corrosion** - If two dissimilar metals are in contact with each other and with an electrolyte e.g. water or other solution, it is possible for a galvanic cell to be set up. This is rather like a battery and can accelerate corrosion of the less 'noble' metal. It can be avoided by separating the metals with a non-metallic insulator such as rubber.

Aluminium and stainless steel together are a galvanic corrosion risk. A large area of 'cathode' relative to 'anode' will accelerate the anodic corrosion. Although aluminium is anodic to stainless steel, large relative surface areas of aluminium to stainless steel can be acceptable,

FILE NAME CSCC-EQ-GN-1001 Rev 2 Anchor Placement & Installation Guidance	 <b>Council of Southern Caving Clubs</b> <small>A constituent member of the British Caving Association</small>	PAGE <b>4 of 11</b>	ISSUE <b>2</b>	DOCUMENT No. <b>CSCC-EQ-GN-1001</b>
---	--	------------------------	-------------------	--

dependant on local conditions. It is essential that aluminium karabiners are not left permanently rigged on stainless steel anchors as over time they will corrode to a fail state.

The CSCC Equipment Officer is responsible for ensuring that any suspected defective anchor is checked and if necessary replaced.

### 3.4 Anchor Resin

The only approved resin used to secure Eco and Peco anchors is KMR RES (it is the same as Resifix 3+ and is manufactured by Exchem). This can be used in dry or damp conditions.

A limitation is that it cannot be used when the temperature falls below -5C. The polyester resin is contained in a large tube with a smaller internal tube containing the activator. Both are expelled simultaneously from the applicator gun and mixing occurs in the nozzle. As the resin and activator pass through the nozzle and mix a colour change takes place. Initially only the cream coloured resin is expelled from the nozzle but as mixing takes place the darker activator turns the output grey. When the colour is a consistent grey with no streaks the resin is ready for use. If an open tube is not used for some time, or curing has taken place in the nozzle between applications, remove the nozzle and remove any hardened resin from the two apertures in the end of the tube. Screw on a new nozzle and again expel the resin/activator until a consistent grey colour is achieved.

Under no circumstances must resin be used after its expiry date. Under no circumstances must resin be used after its expiry date. Two current methods of indicating this date are currently known:

- Date can be found, along with the batch number, on the white horizontal strip at the base of the tube
- Date of manufacture is given, with a 12 month expiry.

It is the responsibility of the installer to have a clear understanding of the expiry date. Any out of date resin must be quarantined and only used in situations where there is no safety risk e.g. fixing the staples on lid hinges. Alternatively it must be returned to the CSCC Equipment Officer or disposed of conforming to current legislation covering hazardous materials.

Only the nozzles supplied should be used for injecting the resin into the holes. Other nozzles are not translucent or may be of a different length, construction and bore. The mixing thread in the centre of the nozzle is not secured and can fall out if knocked or dropped. Check to ensure that it is in position before screwing the nozzle onto the cartridge. All of these factors are critical when using the resin.

Avoid breathing the vapours emitted from the resin. Avoid any skin contact with the resin. Wear gloves and goggles when handling the resin and ensure that you read and understand the precautions supplied with each tube beforehand. The curing time of the resin varies with temperature. A dust mask and goggles should be worn at all times whilst installing anchors.

Times may be longer or even shorter, dependent on ambient temperature. Therefore, a minimum of 12 hours must elapse before an anchor is loaded.

Both the vapour and the resin are flammable. Keep cartridges in secure storage away from naked flames and out of direct sunlight. In the event of fire use a dry powder extinguisher. Sources of ignition e.g. Carbide lamps, cigarette lighters etc. must not be used during anchor installation. The resin curing process is violently exothermic. Ensure that all cloths or tissues used to clean up the installation are wetted down to minimize the risk of combustion.

For the installation of Petzl anchors, the appropriate Petzl resin product must be used.

FILE NAME CSCC-EQ-GN-1001 Rev 2 Anchor Placement & Installation Guidance	 <b>Council of Southern Caving Clubs</b> <small>A constituent member of the British Caving Association</small>	PAGE <b>5 of 11</b>	ISSUE <b>2</b>	DOCUMENT No. <b>CSCC-EQ-GN-1001</b>
---	--	------------------------	-------------------	--

### 3.5 Anchor Placement

Anchors should, where possible, be installed in rock that is sound and not where there are fissures running behind it. To judge if the rock is sound, gently tap the rock with a hammer and listen for resonance. A dull thud or hollow sound might indicate that the proposed installation site harbours unobvious fractures and is potentially unsafe. The degree of resonance that is acceptable is a matter of judgement and any installation in rock will always be subject to some doubt.

Due to the possibility of rock fracture, any placements, even in the soundest rock, should ideally be a minimum of 200mm away from an edge, fracture line, bedding plane or other anchor. However, in real-life situations this is often impossible to achieve and in this case consideration should be given to the alternative anchor types and multiple anchor placements.

It is good practice for the position of the anchors to be agreed by a minimum of two people experienced in the techniques for which the anchors are to be used. This gives a consensus, allowing factors such as proposed usage, rescue, and stability of a remaining anchor following failure of any one anchor to be taken into account when deciding anchor positions.

The first task when installing anchors is to determine their optimum position in relation to the proposed loading. As a general guide, anchors at an SRT pitch head should be placed so that a 'Y' hang has an included angle of less than 90 degrees, although up to 120 degrees is permissible. The loads on each anchor of a 'Y' hang are as follows given that a caver weighing 100Kg is suspended on the rope. It can be seen below that the vector forces exerted on the anchors increase in a rapid non linear fashion as the included angle increases.

Angle in degrees	Approx load in kg
0	50
60	60
90	70
120	100
140	150

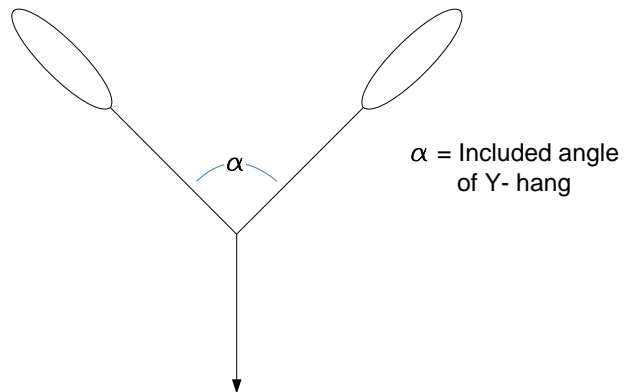

### 3.6 Choice of Anchor Type

The choice of anchor can be a crucial decision. For mechanical anchors a 10mm minimum has become accepted across Europe. The smaller diameter hole requires only 1/3rd of the volume of rock to be excavated when compared to an 'eco' style anchor of similar depth. This makes drilling the hole much quicker, less strenuous in difficult positions and uses less battery power.

Where there is significant fracturing in the rock or the rock is soft or poorly cemented, the use of resin anchors should be considered, since they do not apply a force to the rock until loaded, and spread the load over a wider area. Soft conglomerates have been shown to be particularly unsuitable for mechanical anchors.

For corrosive environments, such as sea caves, resin anchors are a good option.

Corrosion is reduced by not having gaps between parts, which otherwise can lead to crevice corrosion.

### 3.7 Method of Installation for Resin Anchors

Prior to embarking on an anchor installation trip the proposed number of anchors plus a few spares must be cleaned and degreased. This can be achieved by wiping off any contamination with a clean rag and a degreasing solvent. The anchors should then be placed in a container which prevents any further contamination or moisture ingress.

The following procedure refers to a 'Y' hang assembly with Eco Anchors, but the method can easily be adapted for installation of other resin or mechanical anchors and for, deviations, re-belays, traverse lines, ladder and lifeline or for a handline.

Two 18mm diameter holes 100mm deep are drilled into sound rock. Two spare anchors which are not to be used in the installation are then placed in the holes and tapped home. A 'Y' hang using a short piece of rope may then be constructed and the down rope pulled tight in the direction of the proposed load. In certain circumstances sighting the pitch head from the bottom may be helpful in determining anchor positions.

The eyes of the anchors should then be rotated until they are in line with the intended load and the position of the outside of the eye marked on the rock. The 'Y' hang and anchors should then be removed from the holes. A groove leading up to the holes from the marks should then be made so that the whole back of the anchor eye sits in the groove. The junction of the groove and the hole should be radiused to ensure a neat fit. Consideration should also be given to making a groove along the base of the hole in order to prevent rotation of the anchor if the rock resin bond fails. Modifications may need to be made to the groove to accommodate the back of the anchor eye. This ensures that the anchor is not subject to rotational forces when under load. On pull-through routes the anchors should be placed with an angle of 45° between them (Appendix A Figs 5 & 6). When drilling multiple anchor placements it is a good idea to prepare them all before resin is applied. This prevents it curing in the nozzle during application and saves on nozzles.

All the dust must be removed from the hole by flushing it out with plenty of water and brushing until it is clean. A plastic drinking bottle is ideal for this purpose. A piece of lint free absorbent cloth is then used to remove all surplus water. It is vital that the cloth used to dry the hole is not of a type which sheds any fibres as this will affect the rock resin bond.

Ensure that all containers used for flushing are not contaminated with their previous contents and that only clean water is used. Contamination may lead to rock resin bond failure. It is essential that the hole is free from limestone dust and/or limestone paste and water. The strength of the rock resin bond is totally dependent on the cleanliness of the hole.

When using resin always use thin rubber gloves. Resin on the skin can cause contact dermatitis.

Remember to check that the mixing thread is in the nozzle and remove the small cap from the end of the cartridge before screwing on the nozzle and squeezing the applicator handle. Ensure that the resin and activator are extruded until a consistent grey colour is achieved. The drilled hole and the 7mm groove should then be filled with the resin until nearly full taking care to avoid any air bubbles.

Take the clean degreased anchors out of their container; insert them into the resin filled hole with a twisting motion until the back of the eye sits neatly into the 7mm groove. At this point excess resin will be expelled from the hole and groove. Carefully wipe away any surplus and smear it into any gaps around the fixing. Clean the surrounding rock to leave a neat finish.

FILE NAME CSCC-EQ-GN-1001 Rev 2 Anchor Placement & Installation Guidance	 <b>Council of Southern Caving Clubs</b> <small>A constituent member of the British Caving Association</small>	PAGE <b>7 of 11</b>	ISSUE <b>2</b>	DOCUMENT No. <b>CSCC-EQ-GN-1001</b>
---	--	------------------------	-------------------	--

In roof hangs, a small plastic disc approximately 75mm in diameter with a 10mm hole drilled through the centre and split from the periphery to the hole can be placed around the anchor to retain the resin.

Leave to cure for at least 24 hours. In unrestricted caves, a warning label **MUST** be tied on the anchors giving the date and time of installation and the date and time after which the anchor may be used.

Ideally anchors at pitch heads should be reasonably high, but within reach of an average caver. Placing high anchor points for elevated rigging makes access to and from the pitch head easier, reduces fall factors, allows ease of take off and facilitates SRT rescue.

On pull-through routes two separate anchors should be available for all pitches. The anchors can either share the load or be superimposed (Appendix A, Figs 5 & 6). Careful alignment and the angle of the anchors will ensure an easier rope run for retrieval after abseil. Consideration can also be given to using large free running rings attached to the anchor for long pull through pitches to ease rope retrieval. Remember, similar metals should be used to prevent galvanic corrosion.

Existing 8mm S.D. expansion anchors may have cone stressed the rock. They can be left in place as long as they do not compromise the optimum anchor position and are not too close to the proposed permanent anchor. If the 8mm S.D. anchor is within 150mm of a proposed permanent anchor it is best to remove it and enlarge the hole to take the Eco/Peco anchor.

### 3.8 Method of Installation for Mechanical Anchors

Mechanical anchors come in a range of types, lengths and thicknesses. With through bolts a minimum length of 80mm is suggested for good, solid rock but longer shafts (90–120mm) should be considered if the rock is soft or otherwise less than ideal. When tightening mechanical anchors (or placing hangers on glued studs), they should be neither under or over-tightened. An anchor which cannot achieve the recommended torque figure is one which has not gripped, either due to dust in the hole, incorrect hole diameter, or too soft rock, and will not withstand the rated load. Over tightening will permanently damage and weaken the anchor.

Hangers should lie flat against the rock. They should be secure as where they become loose, wear on the anchor can give rise to serious weakening. For most hangers the point at which the karabiner touches the eye should be directly below the centre of the anchor. If the anchor has to be inserted on an overhanging wall (and is therefore off-vertical) a pull will result in leverage on the hanger. For some hanger shapes, placing them upside-down brings the karabiner closer to the anchor and so creates less leverage but this probably contravenes the manufacturer's recommendations.

### 3.9 Method of Anchor Removal

If an anchor is to be completely removed, a dust mask and goggles should be worn.

To remove an eco anchor, drill into the resin to a depth of 100mm around the anchor using a drill bit suitable for drilling metal (a 6mm drill bit would be appropriate for this use). This should weaken or break the rock resin bond.

Then use the CSCC puller to remove the anchor from the rock.

Consideration should be given to filling the resulting hole to preserve the aesthetics of the cave.

FILE NAME CSCC-EQ-GN-1001 Rev 2 Anchor Placement & Installation Guidance	 <b>Council of Southern Caving Clubs</b> <small>A constituent member of the British Caving Association</small>	PAGE <b>8 of 11</b>	ISSUE <b>2</b>	DOCUMENT No. <b>CSCC-EQ-GN-1001</b>
---	--	------------------------	-------------------	--



## Appendix A

**Figure 1** The anchors should be angled so that they are in line with the direction of the load; the angle ' $\alpha$ ' must not exceed  $120^\circ$ .

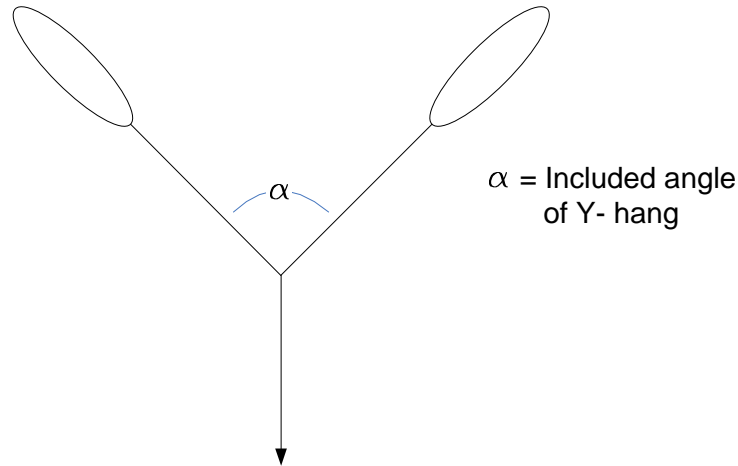

**Figure 2** Indicates the **correct** alignment of the anchors, in relation to the direction of the load.

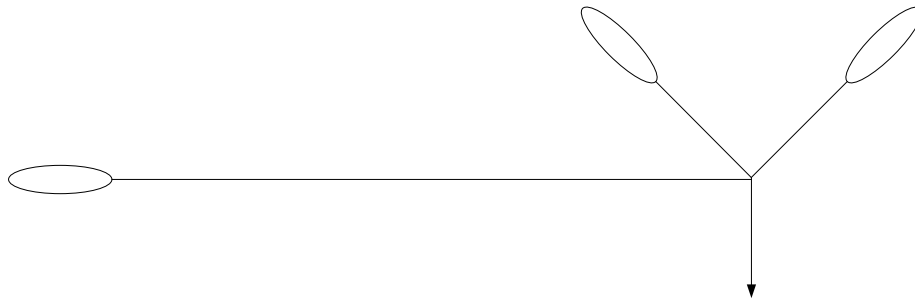

**Figure 3** Indicates the **incorrect** alignment of the anchors, in relation to the direction of the load.

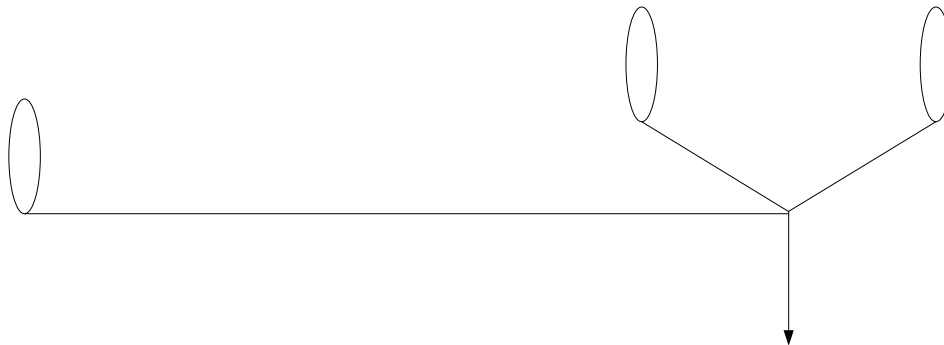

**Figure 4** All anchors are inline with the direction of the load, thus, no anchor has lateral stressing.

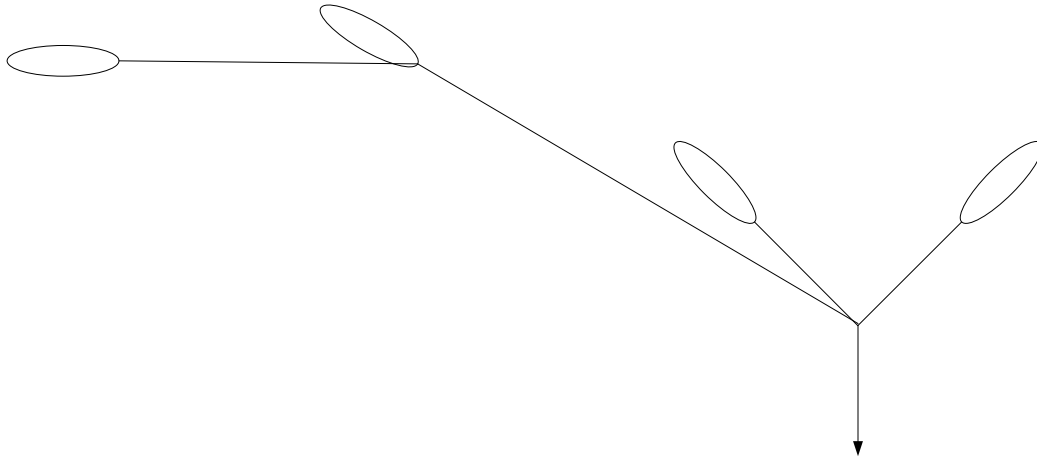

**Figure 5** Indicates the correct placement of anchors on pull through routes while sharing the load. Anchors should be a minimum of 20cm apart and the angle at ' $\alpha$ ' should be as close to 45° as practicable.

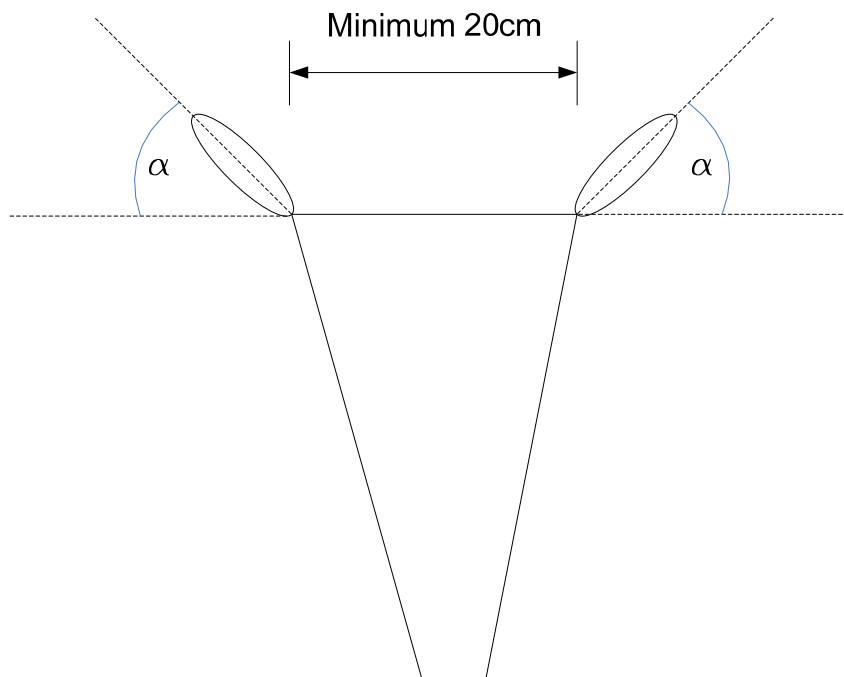

**Figure 6** Indicates the correct placement of anchors on pull through routes where the anchor placement is superimposed. Anchors should be a minimum of 20cm apart and the angle at ' $\alpha$ ' should be as close to 45° as practicable.

